

## FITTING INSTRUCTIONS for...

- TRIUMPH Tiger 900 GT ('24 on)
- TRIUMPH Tiger 900 GT PRO ('24 on)
- TRIUMPH Tiger 900 RALLY PRO ('24 on)

### Preparation

Remove the original handguards (if fitted) and original bar end weights.

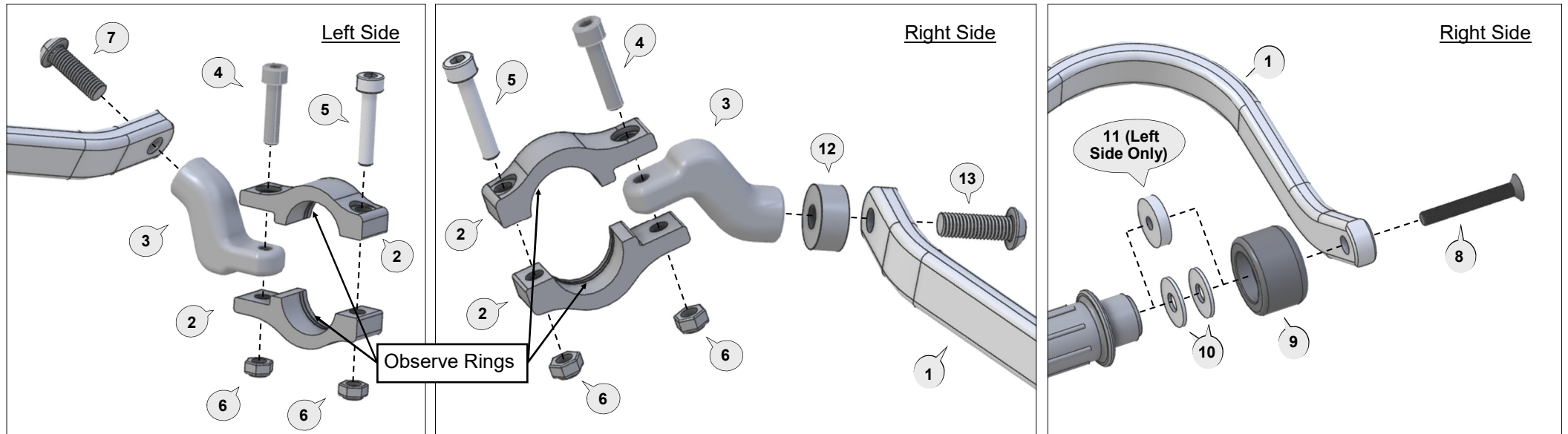

### Fitting Procedure for left side

Loosely assemble clamp (2) to handlebar as per diagram. Attach backbone (1) with applicable parts to the handlebar and also to the clamp connector (3).

**Note:** Preferred backbone position is horizontal when viewed from side.  
Tighten bolt (8) at the handlebar end.

Tighten Clamp bolts in the following order:

**Tighten bolt (7)** through the aluminium bar (1) to the clamp connector (3) of the clamp assembly.

**Tighten bolt (4)** to solidly lock the clamp connector (3) between the clamp saddles (2).

**Tighten bolt (5)** to secure the clamp assembly firmly to the handlebar.









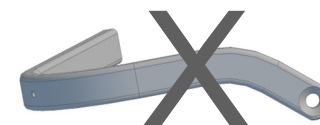
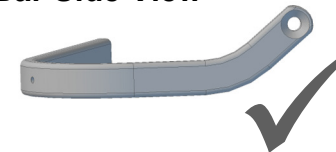





**Note:** The clamp is designed to allow the nut (6) on bolt (4) to pull into the recessed hole. This eliminates the need for a wrench after the bolt starts to tighten.

Repeat the above procedure for the right side with the applicable parts shown on above diagram.

Use recommended torque specifications over page.

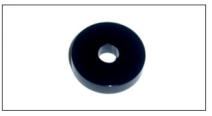
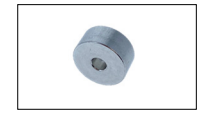
### Bar Side View



<b>1</b> Aluminium Bar  PN: BAR-V-046 Pcs. 1 Left & 1 Right	<b>2</b> Clamp Saddle  PN: CS-02 Pcs. 4	<b>3</b> Clamp Connector  PN: CP5 Pcs. 2	<b>4</b> Socket Head Bolt 25mm  PN: M6x25SHCSZP Pcs. 2	<b>5</b> Socket Head Bolt 30mm  PN: M6x30SHCSZP Pcs. 2	<b>6</b> Nylock Nut  PN: M6LN Pcs. 4	<b>7</b> Button Head Bolt 25mm  PN: M8x25BHCSZP Pcs. 1	<b>8</b> Flat Head Bolt 45mm  PN: M6x45FHCSZP Pcs. 2
<b>9</b> Bar End Weight  PN: BEW-35 Pcs. 2	<b>10</b> Washer  PN: M8FW-SS Pcs. 2	<b>11</b> Spacer  PN: SP-05 Pcs. 1	<b>12</b> Spacer (10mm)  PN: BSSRT10 Pcs. 1	<b>13</b> Button Head Bolt 35mm  PN: M8x35BHCSZP Pcs. 1	<b>Personalise Your Protection</b> Guard options sold separately  <b>JET-003</b>  <b>VPS-003</b>  <b>STM-003</b> <b>CARBON</b> <b>BCF-003</b>		

Recommended Torque Settings	
M6	10 Nm (7.4 lbf ft)
M8	20 Nm (14.8 lbf ft)

**CAUTION:**

Installation of the handguard is safety-relevant work and can be complicated. We recommend the installation be performed by a motorcycle service technician. Rideworx accepts no liability for damages caused by improper mounting. All screws, bolts and nuts, including all replacement hardware provided by Rideworx, should be tightened to the torque specified in the below table. After the first 50km of riding check all screws, bolts and nuts are tightened to the correct torque. We recommend a medium strength liquid thread lock product on all fasteners.

**WARNING:**

It is important there is a working clearance (approx 3mm) between the throttle grip end and the handguard to ensure a free closing throttle. Check operation of all handlebar controls, specifically the throttle, front brake, kill switch and clutch to ensure they are operating correctly and are in accordance with the OEM specifications. Do not ride the motorcycle if any controls are not operating correctly. Check periodically that all bolts are tight.

**Disclaimer:**

A failure to follow these fitting instructions could cause serious injury, death or property damage. These handguards are intended solely for use with motorcycles/ATV/snowmobiles/scooters that have not been modified. They are not designed to prevent injury or death while riding or in an accident or crash. The user must ensure that all controls are free of the handguards every time that they ride. By installing and/or using this product you acknowledge that you accept these terms and have followed the fitting instructions.



Phone: +61 (0)2 4271 8244  
 Email: info@barkbusters.net  
 Web: www.barkbusters.net



### Option for fitting with **Single Point Handlebar Mount**

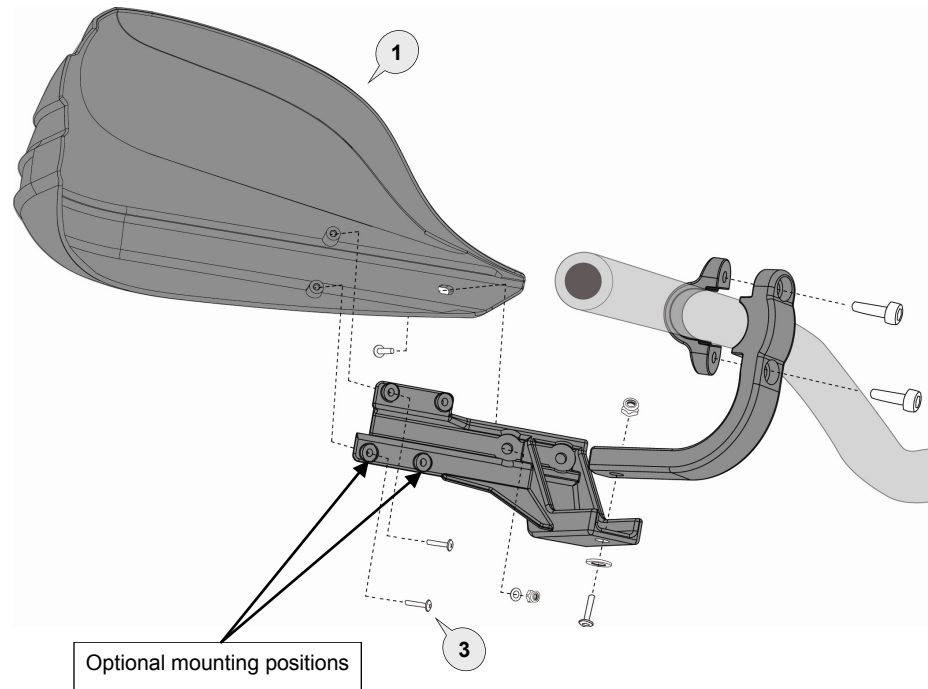

### Option for fitting with **Aluminium Backbone**

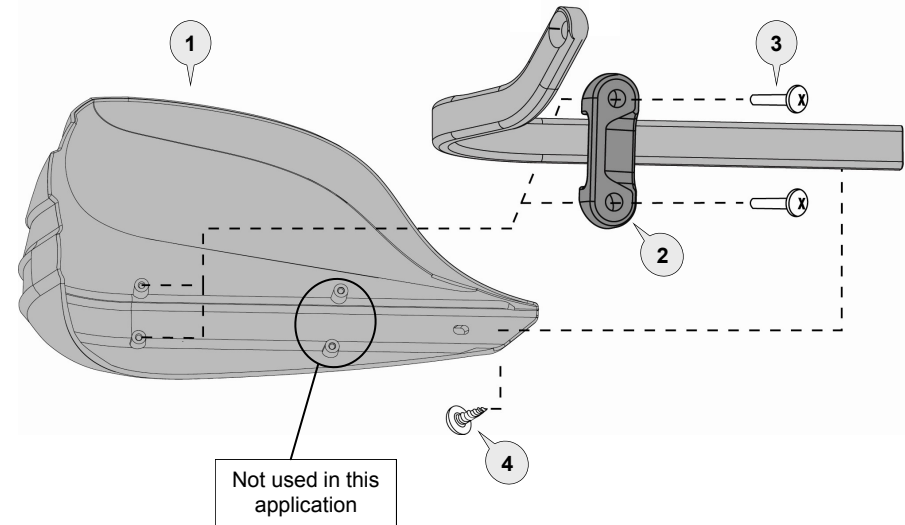



**CAUTION:**

Installation of the handguard is safety-relevant work and can be complicated. We recommend the installation be performed by a motorcycle service technician. Rideworx accepts no liability for damages caused by improper mounting. All screws, bolts and nuts, including all replacement hardware provided by Rideworx, should be tightened to the torque specified in the below table. After the first 50km of riding check all screws, bolts and nuts are tightened to the correct torque. We recommend a medium strength liquid thread lock product on all fasteners.

**WARNING:**

Check operation of all handlebar controls, specifically the throttle, front brake, kill switch and clutch to ensure they are operating correctly and are in accordance with the OEM specifications. Do not ride the motorcycle if any controls are not operating correctly. Check periodically that all bolts are tight.

**Disclaimer:**

*A failure to follow these fitting instructions could cause serious injury, death or property damage. These handguards are intended solely for use with motorcycles/ATV/snowmobiles/scooters that have not been modified. They are not designed to prevent injury or death while riding or in an accident or crash. The user must ensure that all controls are free of the handguards every time that they ride. By installing and/or using this product you acknowledge that you accept these terms and have followed the fitting instructions.*



Phone: +61 (0)2 4271 8244  
Email: [info@barkbusters.net](mailto:info@barkbusters.net)  
Web: [www.barkbusters.net](http://www.barkbusters.net)

