

# ANBAUANLEITUNG

mounting instructions • instructions de montage • instrucciones de montaje • istruzioni di montaggio

## BC.HTA.11.740.36100

beinhaltet • contains • contient • contiene • contiene

HTA.11.740.86100/B

BC.HTA.00.740.31000

Numero di articolo: HTA.11.740.86100/B

Revisione: 00 · Data: 03 - 2024

**Barre distanziatrici rimovibili BLAZE** ~ 0.75 h.FACILE     DIFFICILE

**ITALIANO** -Grazie per aver scelto questo prodotto premium di SW-MOTECH. Visita il nostro negozio online per ulteriori informazioni (ad es. per la compatibilità con i vari modelli). I documenti richiesti (ad es. certificato di omologazione nazionale) possono essere scaricati qui.

**Si prega di leggere attentamente le avvertenze di sicurezza e le istruzioni per il montaggio prima di montare e utilizzare il prodotto, al fine di evitare eventuali lesioni e danni. Conserva queste istruzioni per il montaggio come riferimento futuro.**

**Questo prodotto è stato sviluppato per veicoli in condizioni di fabbrica. La compatibilità con gli accessori originali o di altri produttori non può essere garantita.**

**Queste istruzioni per il montaggio sono state redatte in base alle nostre conoscenze attuali. Non sussistono pretese di correttezza giuridiche. Salvo errori ed omissioni. Ci riserviamo il diritto di apportare modifiche tecniche e di design. Copyright SW-MOTECH.**

**SIMBOLO DI SICUREZZA**

 Questo simbolo di avvertenza è usato nelle presenti istruzioni di montaggio per segnalare pericoli mortali, rischio di lesioni o altri pericoli. Le parole "PERICOLO", "AVVERTENZA" O "ATTENZIONE" sono utilizzate con questo simbolo di avvertenza per trasmettere importanti istruzioni di sicurezza e informazioni relative al montaggio e all'uso di questo prodotto. Queste parole, utilizzate insieme al simbolo di avvertenza, significano:

**▲ PERICOLO:** indica una situazione di pericolo che, se non evitata, può causare morte o lesioni gravi!

**▲ AVVERTENZA:** indica una situazione di pericolo che, se non evitata, può causare morte o lesioni gravi!

**▲ ATTENZIONE:** indica una situazione di pericolo che, se non evitata, può provocare lesioni lievi o di entità moderata!

**▲ AVVISO:** indica informazioni importanti che non riguardano il rischio di morte o di lesioni (riguardano unicamente il rischio di danni materiali)!

**INFORMAZIONI GENERALI**

**▲ AVVERTENZA:** il montaggio e/o la manutenzione di questo prodotto richiedono competenze tecniche avanzate, strumenti adeguati e una buona conoscenza dell'uso della strumentazione e delle indicazioni relative alle coppie di serraggio. Per ragioni di sicurezza, SW-MOTECH raccomanda di far eseguire il montaggio e/o la manutenzione presso un'officina per motociclette qualificata e certificata.

**▲ AVVERTENZA:** se si decide di installare questo prodotto in autonomia, leggere attentamente le istruzioni per il montaggio prima del montaggio e dell'uso e seguire tutte le avvertenze per evitare lesioni gravi o mortali. Durante il montaggio e l'uso, seguire anche tutte le istruzioni pertinenti contenute nel manuale del veicolo. **SE NON SI COMPRENDONO TALI ISTRUZIONI, ANCHE SOLO IN PARTE, O SE SONO NECESSARI CHIARIMENTI, NON CERCARE DI MONTARE IL PRODOTTO IN AUTONOMIA SENZA CHIEDERE IL SUPPORTO DI SW-MOTECH!**

**PREPARAZIONE:** leggere attentamente le istruzioni per il montaggio e assicurarsi che siano disponibili tutti i componenti contenuti nella lista.

**▲ ATTENZIONE:** assicurarsi che il veicolo sia perfettamente fermo. Spegner il motore e togliere la chiave. Se necessario, lasciar raffreddare il motore/lo scarico. Scollegare la batteria quando si interviene sull'impianto elettrico. Usare esclusivamente strumenti idonei e indossare sempre occhiali e guanti protettivi durante le operazioni di montaggio e manutenzione. Chiedere aiuto a una seconda persona durante le fasi di montaggio e manutenzione.

**MONTAGGIO:** tutti i componenti e i collegamenti rimossi dal veicolo devono essere reinstallati secondo le specifiche del produttore del veicolo o sostituiti con componenti e attrezzatura forniti da SW-MOTECH.

**▲ AVVERTENZA:** fissare tutte le filettature con frenafili liquido a media resistenza, se non diversamente specificato.

**▲ PERICOLO:** le coppie di serraggio non definite da SW-MOTECH devono essere richieste al costruttore del veicolo o a un'officina certificata.

**CONTROLLO DI FUNZIONALITÀ:** dopo il montaggio accertarsi che non vi siano parti mobili bloccate e che il funzionamento del veicolo non sia compromesso. I cavi e i tubi flessibili non devono sfregare e/o essere schiacciati.

**▲ AVVERTENZA:** eseguire un controllo completo delle funzioni prima di mettersi alla guida. Controllare la coppia di serraggio di tutti i collegamenti e la tenuta del prodotto dopo i primi 50 km e in seguito regolarmente. Gli accessori montati possono modificare la maneggevolezza e la stabilità del veicolo.



SW-MOTECH GmbH & Co. KG  
Ernteweg 7-10  
35282 Rauschenberg  
Germania



info@sw-motech.com  
www.sw-motech.com



Consultare i simboli e il loro significato nella sezione MONTAGGIO. Se nella sezione montaggio compare la sigla OEM, è necessario rispettare e applicare le specifiche del produttore del veicolo.



Per qualsiasi domanda, non esitare a contattare il nostro servizio clienti o i nostri distributori. Il nostro numero di telefono e l'elenco dei nostri distributori sono disponibili nel nostro negozio online:

**[www.sw-motech.com](http://www.sw-motech.com)**



**Non utilizzare il frenafiletti:** segnala di non dover utilizzare il frenafiletti liquido in quel determinato punto.



**Serraggio / rispetto delle specifiche sulla coppia di serraggio:** indica la coppia di serraggio di un componente specificata da SW-MOTECH o dal produttore del veicolo (OEM).



**Usare un frenafiletti:** indica che la filettatura deve essere rivestita con un frenafiletti liquido. H (ALTA): alta resistenza; M (MEDIA): media resistenza; L (BASSO): bassa resistenza.

ELENCO DELLE PARTI - LEGGI E CONSERVA LE ISTRUZIONI DI MONTAGGIO!

<p><b>1</b></p> <p><b>1</b></p>  <p>HTA.11.740.028L.11</p> <p> 1/1</p>	<p><b>2</b></p> <p><b>2</b></p>  <p>HTA.11.740.028R.11</p> <p> 1/1</p>	<p><b>3</b></p> <p><b>3</b></p>  <p>HTA.00.740.033L.02</p> <p> 1/1</p>	<p><b>4</b></p> <p><b>4</b></p>  <p>HTA.00.740.033R.02</p> <p> 1/1</p>	<p><b>5</b></p>  <p>M5 x 8; ISO 7380 SC.A2.05.008.01.7380.M3</p> <p> 4/4</p>	<p><b>6</b></p>  <p>M5 x 16; DIN 6912 SC.ST.05.016.02.6912.088</p> <p> 2/6</p>
<p><b>7</b></p>  <p>∅ 5,3; DIN 125 US.ST.053.02.125</p> <p> 2/2</p>	<p><b>8</b></p>  <p>M5; DIN 6927 MU.ST.05.02.6927.08</p> <p> 2/2</p>	<p><b>9</b></p>  <p>M5 x 12; ISO 7380 SC.A2.05.012.01.7380.M3</p> <p> 2/2</p>	<p><b>10</b></p>  <p>∅ 5,3; DIN 9021 US.A2.053.01.9021</p> <p> 2/2</p>		
<p><b>2</b></p> <p><b>11</b></p>  <p>HTA.06.740.A01L.01</p> <p> 1/1</p>	<p><b>12</b></p>  <p>HTA.06.740.A01R.01</p> <p> 1/1</p>	<p><b>13</b></p>  <p>KES.RD.150.0200.02.GL</p> <p> 2/2</p>	<p><b>14</b></p>  <p>HTA.00.740.532.01</p> <p> 1/1</p>	<p><b>15</b></p>  <p>HTA.00.740.531.01</p> <p> 1/1</p>	<p><b>16</b></p>  <p>M5 x 16; DIN 6912 SC.ST.05.016.02.6912.088</p> <p> 4/6</p>
<p><b>17</b></p>  <p>M5; DIN 985 MU.A4.05.01.985.70</p> <p> 4/4</p>					
<p><b>4</b></p> <p><b>18</b></p>  <p>M8 x 30; DIN 912 SC.ST.08.030.02.912.088</p> <p> 4/4</p>	<p><b>19</b></p>  <p>∅ 8,4; DIN 125 US.ST.084.02.125</p> <p> 4/4</p>				

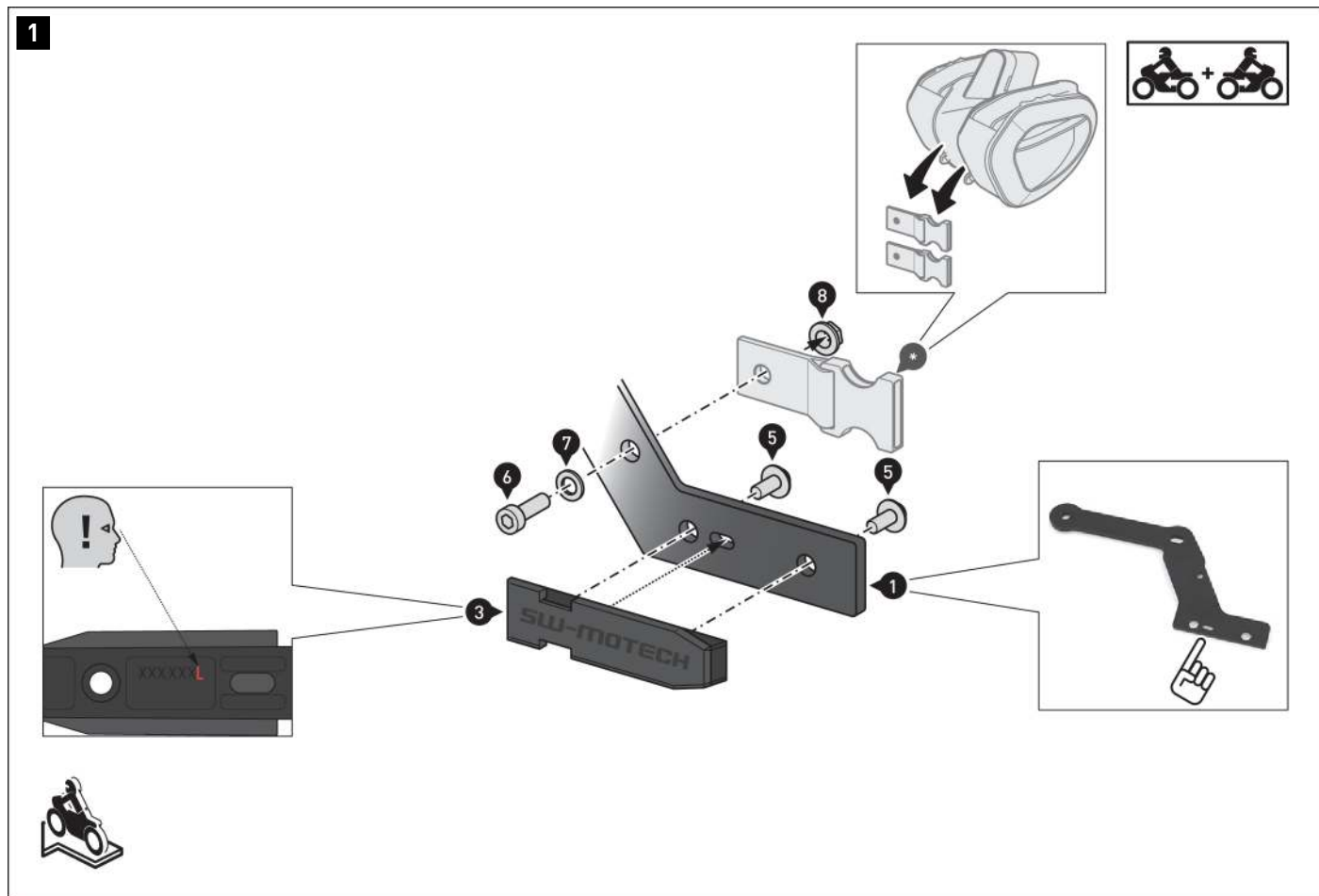

⚠ **AVVISO:** questa fase di montaggio non prevedene viti (9) né rondelle (10).

⚠ **AVVERTENZA:** indossare sempre le protezioni per gli occhi e per le mani!  
 ⚠ **AVVERTENZA:** Utilizzare sempre strumenti adeguati!

⚠ **AVVISO:** i seguenti passaggi di installazione mostrano il montaggio su un lato. Ripetere i medesimi passaggi di installazione sull'altro lato del veicolo, salvo ove diversamente indicato.

⚠ **AVVISO:** la riproduzione grafica della staffa di montaggio (1) è a scopo puramente esemplificativo. Avvitare le guide per i connettori (3/4) sul lato delle staffe di montaggio (1/2) indicato nella suddetta illustrazione grafica.

Avvitare la guida per il connettore (3) contrassegnata con la **lettera L** sulla staffa di montaggio (1).

Avvitare infine la guida per il correttore (4) contrassegnata con la **lettera R** alla staffa di montaggio (2).

Serrare le viti (5) come specificato nelle istruzioni per il montaggio.

⚠ **ATTENZIONE:** un serraggio eccessivo delle viti (5) danneggerà le parti in plastica!

Rimuovere le fibbie (\*) dalle borse laterali.

Avvitare le fibbie (\*) sul retro della staffa di montaggio (1/2).

Non serrare ancora le viti (6).

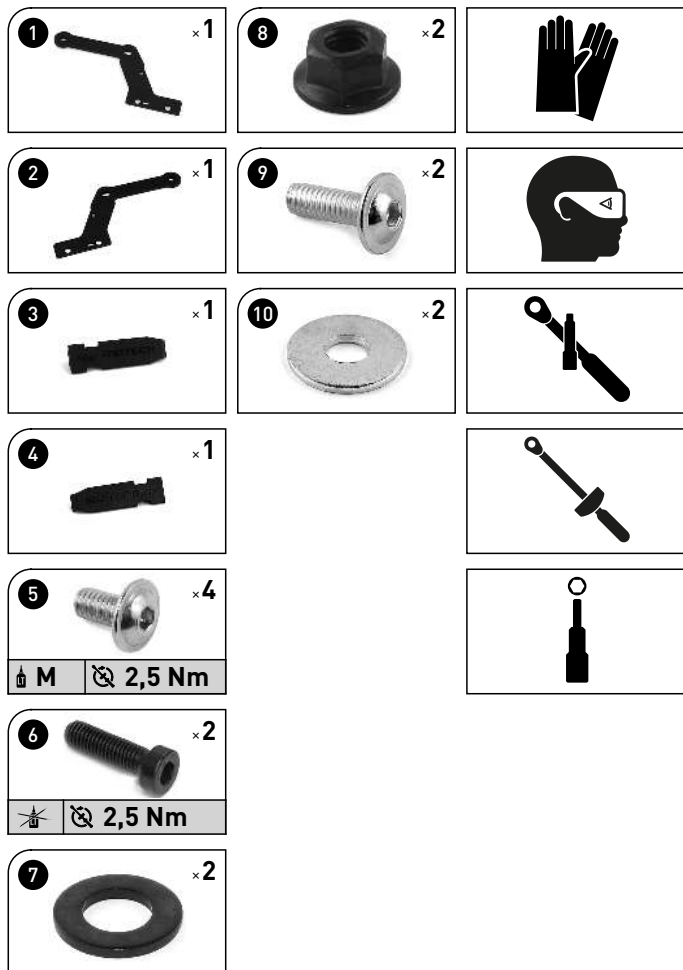

2

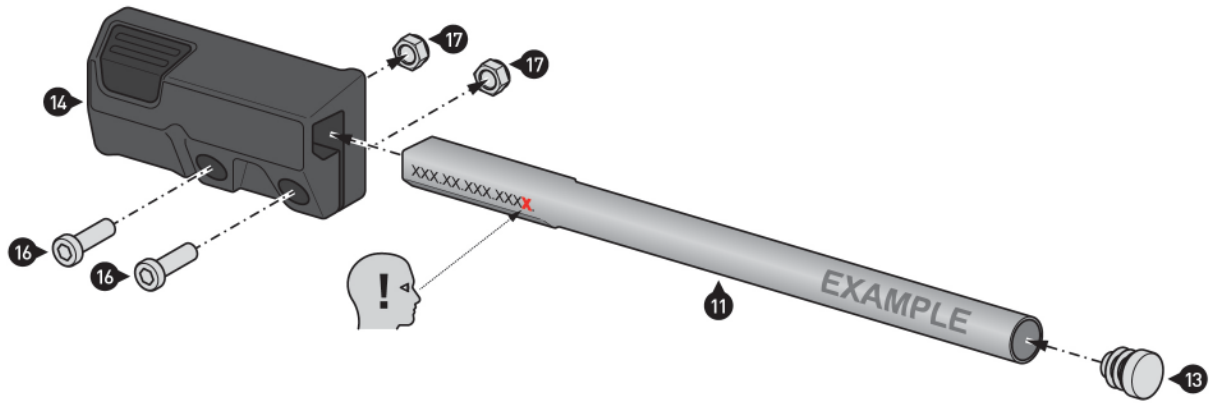

Inserire i tappi di plastica (13) nelle estremità delle barre distanziatrici (11/12).

Inserire la barra distanziatrice (11) contrassegnata con la **lettera L** nell'apertura del connettore (14) contrassegnato con la **lettera R**. Quindi inserire la barra distanziatrice (12) contrassegnata con la **lettera R** nell'apertura del connettore (15) con la **lettera L**. Serrare le viti (16) come specificato nelle istruzioni per il montaggio.

**⚠ ATTENZIONE: un serraggio eccessivo delle viti (16) danneggerà le parti in plastica!**

**⚠ AVVERTENZA: al termine controllare che le barre distanziatrici (11/12) siano saldamente inserite!**

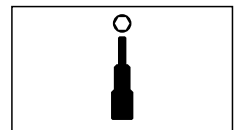
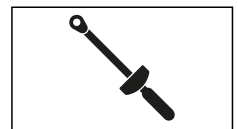
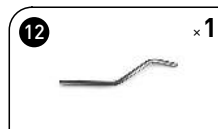
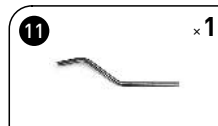

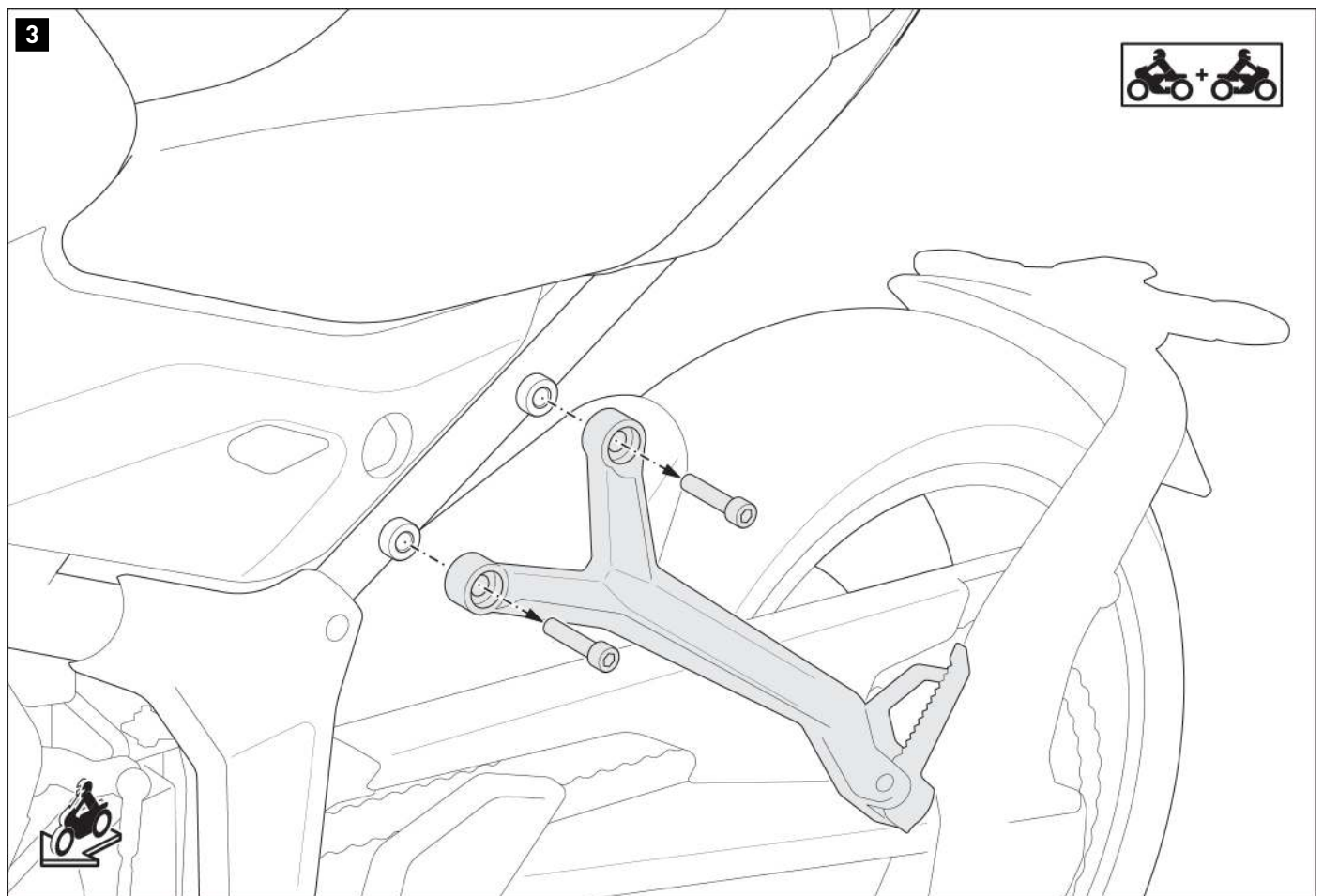

Rimuovere le viti originali indicate dal veicolo.

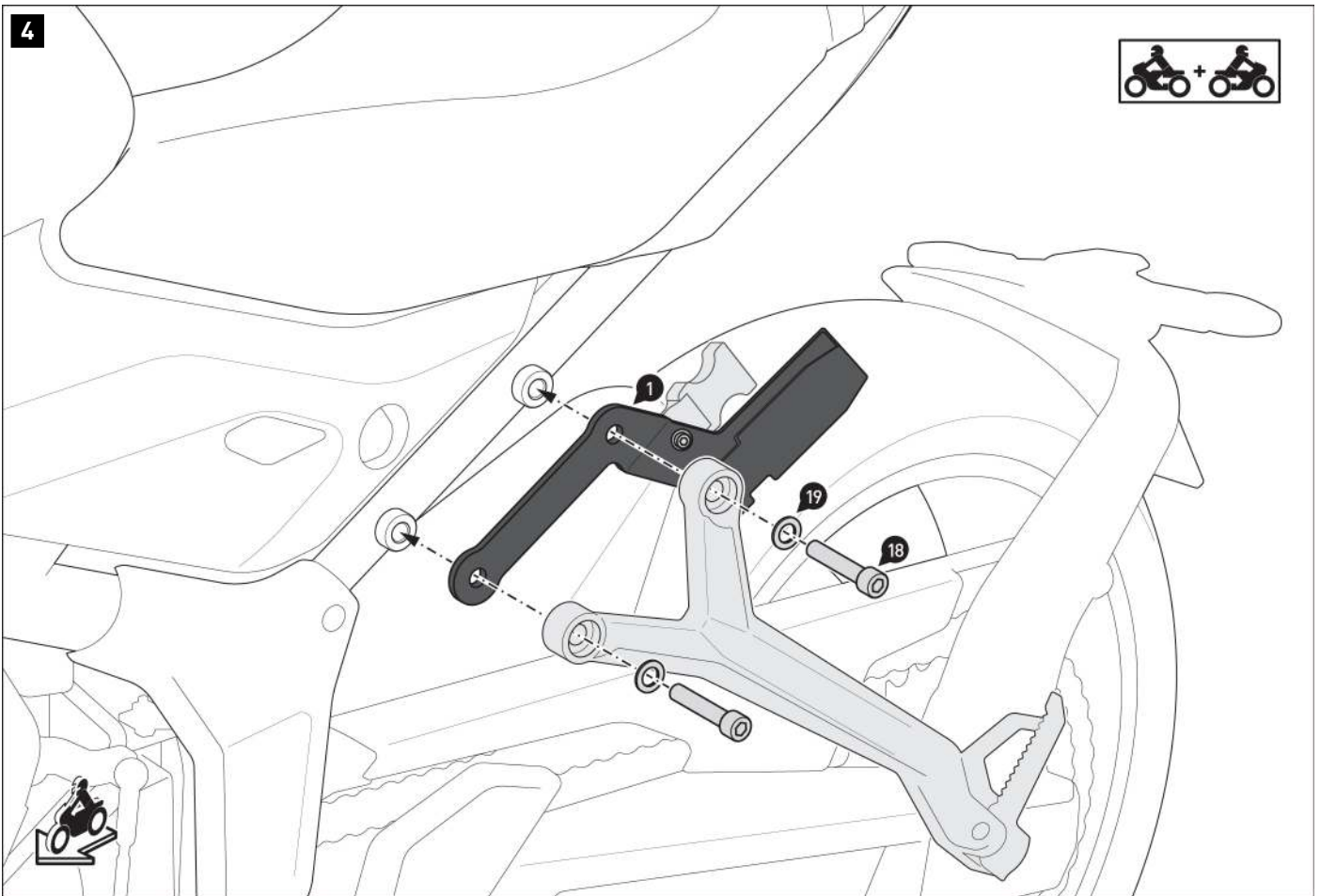

Avvitare le staffe di montaggio (1/2) al supporto della pedana passeggero sul veicolo.

**▲ AVVERTENZA: Usare un frenafretili liquido!**

Serrare le viti (18) come specificato nelle istruzioni del produttore.

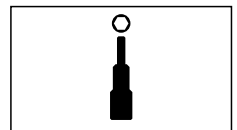
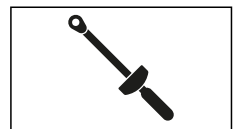



5

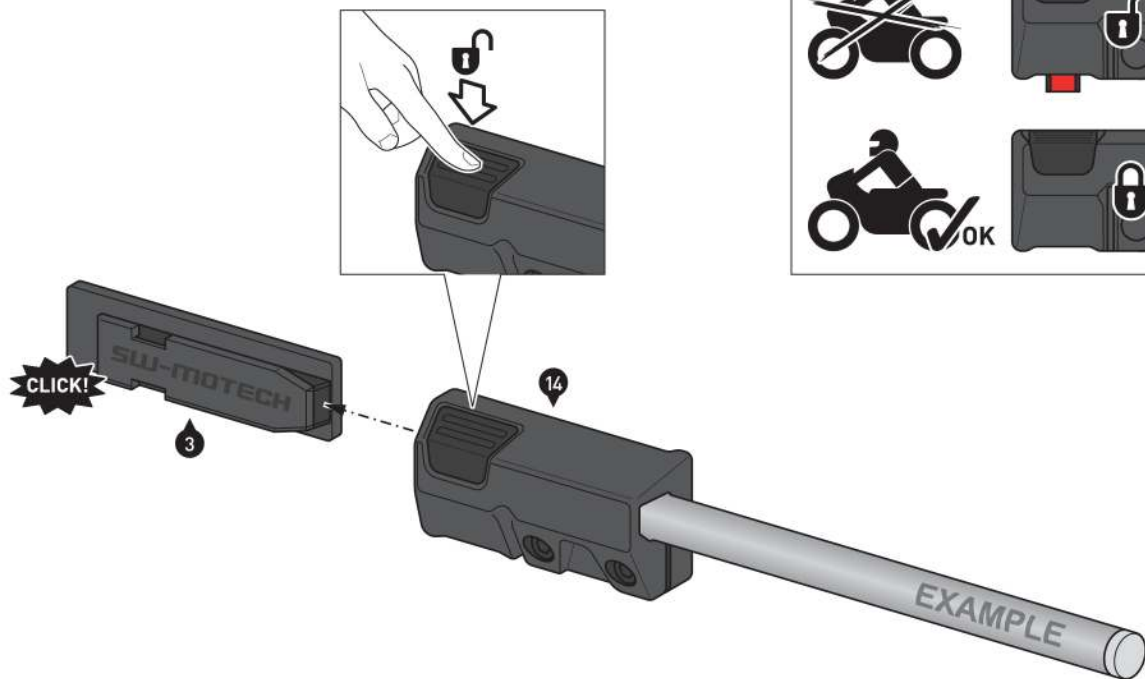

Inserire e spingere i connettori (14/15) nelle relative guide su entrambi i lati (3/4).

**▲ ATTENZIONE:** durante l'inserimento, prestare attenzione allo scatto sonoro! Assicurarsi inoltre che le superfici rosse di avvertimento dei pulsanti di sblocco non siano visibili, altrimenti la tenuta del supporto non sarà garantita (vedi disegno in scala)!

**▲ AVVERTENZA:** prima di fissare le borse laterali alle barre distanziatrici, accertarsi di osservare le istruzioni per il montaggio allegate alle borse!

**DOPO** aver fissato le borse laterali, serrare i viti (6) su entrambi i lati, come specificato nelle istruzioni per il montaggio.

**▲ ATTENZIONE:** un serraggio eccessivo delle viti (14) danneggerà le parti in plastica!

**▲ AVVERTENZA:** prima di mettersi in viaggio, verificare che tutti i componenti siano saldamente fissati! In occasione di viaggi **SENZA** borse laterali, rimuovere i connettori (14/15) dal veicolo!

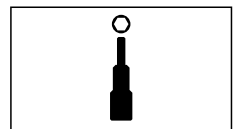
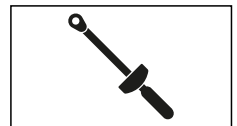

**AVVERTENZE SPECIFICHE DEL PRODOTTO**

**▲ AVVERTENZA:** assicurarsi di seguire le istruzioni per il montaggio  
allegate alle borse laterali!

**▲ AVVISO:** Osservare le normative specifiche del paese per l'immatricolazione/il  
funzionamento del veicolo o le norme TÜV applicabili. Dopo l'assemblaggio, far  
inserire le parti soggette a omologazione nei documenti del veicolo dal proprio  
centro di test.

Art.-Nr. / Item No.: **BC.HTA.00.740.3000\* & BC.HTA.00.740.3100\***

Revision: **00** · Datum / Date: **09 - 2020**

**PRO BLAZE® Satteltaschen  
PRO BLAZE® Satteltaschen hohe Version**

**PRO BLAZE® saddlebags  
PRO BLAZE® saddlebags high version**

**DEUTSCH** - Vielen Dank, dass Sie sich für dieses Premium-Produkt von SW-MOTECH entschieden haben. Bitte besuchen Sie unseren Webshop für weitere Informationen wie Modellzuweisungen und PDF-Anbauanleitung. Erforderliche Dokumente (z. B. ABE) stehen als Download zur Verfügung.

Die Montage und/oder Wartung dieses Produkts erfordert ein gutes technisches Verständnis! Zu Ihrer eigenen Sicherheit empfiehlt SW-MOTECH, die Montage und/oder Wartung durch eine Fachwerkstatt durchführen zu lassen! SW-MOTECH übernimmt keine Haftung für Schäden, die durch eine unsachgemäße Montage und/oder Wartung verursacht wurden!

Beachten Sie alle in der Anbauanleitung angegebenen Hinweise und die für die Montage relevanten Informationen im Fahrzeughandbuch. Nichtbeachtung kann zu Schäden am Fahrzeug bzw. zur Gefährdung des Fahrers führen! Diese Anbauanleitung ist nach unserem derzeitigen Kenntnisstand verfasst worden. Rechtliche Ansprüche auf Richtigkeit bestehen nicht.

Dieses Produkt wurde für Fahrzeuge im Werkzustand entwickelt. Die Kompatibilität mit Original-Zubehörteilen bzw. den Zubehörteilen anderer Hersteller kann nicht gewährleistet werden. Stellen Sie des Weiteren VOR Montage dieses Produkts sicher, dass sich alle beweglichen Teile (z. B. die Kette) im ursprünglichen Wartungszustand befinden. Montiertes Zubehör kann das Fahrverhalten und/oder die Stabilität Ihres Fahrzeugs verändern.

**ALLGEMEINE HINWEISE**

Beachten Sie die landesspezifischen Vorschriften für Zulassung/Betrieb Ihres Fahrzeugs bzw. anwendbare TÜV-Vorschriften. Lassen Sie eintragungspflichtige Teile nach Montage durch Ihre Prüfstelle in die Fahrzeugpapiere eintragen.

**VORBEREITUNG:** Lesen Sie die Anbauanleitung aufmerksam und stellen Sie sicher, dass alle Teile der Stückliste vorhanden sind. Achten Sie darauf, dass Ihr Fahrzeug sicher steht und nicht umfallen kann. Schalten Sie den Motor ab und ziehen Sie den Zündschlüssel. Lassen Sie ggf. den Motor/Auspuff abkühlen. Klemmen Sie bei Arbeiten an der Elektrik die Fahrzeugbatterie ab. Verwenden Sie geeignetes Werkzeug. Lassen Sie sich von einer zweiten Person helfen.

**FUNKTIONSKONTROLLE:** Prüfen Sie nach der Befestigung die uneingeschränkte Freigängigkeit und einwandfreie Funktion aller Fahrzeugteile. Leuchtmittel wie Rücklicht und Blinker dürfen nicht in ihrer Funktion eingeschränkt werden. Kabel, Züge und Schläuche dürfen nicht scheuern und/oder geklemmt werden. Führen Sie vor Fahrtbeginn eine umfassende Funktionskontrolle durch.

**ACHTUNG: Überprüfen Sie vor Fahrtbeginn und bei jeder Rast (alle 200 km) den ordnungsgemäßen Sitz des Produkts!**

**ACHTUNG: Die Kompatibilität mit Zubehör-Auspuffanlagen kann nicht gewährleistet werden!**

Stellen Sie sicher, dass keine Komponente des Produkts mit heißen und beweglichen Teilen des Fahrzeugs in Berührung kommen kann. Achten Sie darauf, dass alle Komponenten mindestens 5 cm Abstand zu heißen Teilen sowie dem heißen Abgasstrom des Auspuffs haben. Federn Sie zu diesem Zweck nach der Montage das Fahrzeug mehrere Male im Stand voll durch.

**PRODUKTSPEZIFISCHE HINWEISE**

**ACHTUNG: Das Fahr-/Bremsverhalten des Motorrads verändert sich nach Befestigung dieses Produkts merklich! Die Schräglagen- und Bodenfreiheit kann durch dieses Produkt eingeschränkt werden!**

**ACHTUNG: Veränderungen führen zum Erlöschen der Garantie.**

Maximale Zuladung	Höchstgeschwindigkeit
 <b>5 KG (11 lbs)</b>	 <b>130 km/h (80 mph)</b>

**ACHTUNG: Es gilt die vom Fahrzeughersteller genannte maximale Zuladung des Fahrzeugs!**

**ACHTUNG**   
**NICHT FÜR DEN OFFROAD-EINSATZ GEEIGNET!**

**ENGLISH** - Thank you for choosing this premium product from SW-MOTECH. Please visit our webshop for additional information, such as application charts and PDF mounting instructions. Any other documents that may be required (e.g. ABE certifications), are also available for download at our webshop.

Installation and/or maintenance of this product require good technical understanding! For your own safety SW-MOTECH recommends having installation and/or servicing carried out by a specialist workshop! SW-MOTECH assumes no liability for damage caused by improper installation and/or maintenance work!

Carefully follow all the directions given in the mounting instructions and pay attention to all relevant information in the vehicle manual during assembly. Nonconformance can lead to vehicle damage or even endanger the driver! These mounting instructions are written based on our current state of knowledge. Legal requirements for accuracy do not exist.

This product was developed for vehicles in their factory setting. Compatibility with original accessory parts or other manufacturers' accessory parts is not guaranteed. Furthermore, BEFORE installing this product, make sure that all moving parts (e.g. the chain) are in the original state of maintenance. Installed accessories can change the driving behaviour and/or stability of your vehicle.

**GENERAL INFORMATION**

Observe the country-specific regulations concerning vehicle registration/operation as well as TÜV regulations if applicable. If required, register installed parts in the vehicle documents through an appropriate inspection authority.

**PREPARATION:** Read the mounting instructions carefully and make sure that all items of the parts list are included. Make sure that your vehicle is parked safely and cannot fall over. Turn off the engine and remove the ignition key. Let the motor/exhaust cool off if necessary. Disconnect the vehicle battery when working on the electrical system. Use appropriate tools. Have another person to help you.

**FUNCTION CHECK:** After fixation also make sure that no moving parts are obstructed and the function of the vehicle is not hindered in any way. Lamps as taillight and turn signals must not be limited in their function. Cables and hoses must not rub and/or be pinched. Before starting to ride, perform a comprehensive check of all functions.

**ATTENTION: Before riding and at each stop (every 200 km) check proper fixation of the product!**

**ATTENTION: Compatibility with accessory exhaust systems cannot be guaranteed!**

All components of the product must not contact any hot or moving parts of the vehicle. All parts should also remain 5 cm away from hot parts of the vehicle and remain clear of the exhaust stream. For this reason compress the suspension fully several times with your vehicle stationary.

**PRODUCT SPECIFIC INFORMATION**

**ATTENTION: Riding with this product may affect the motorcycles driving and braking performance! Cornering and ground clearance can be reduced by using this product!**

**ATTENTION: Modifications will void any warranty.**

Maximum Load	Maximum Speed
 <b>5 KG (11 lbs)</b>	 <b>130 km/h (80 mph)</b>

**ATTENTION: The maximum vehicle load specified by the manufacturer must not be exceeded!**

**ATTENTION**   
**NOT FOR OFFROAD-USE!**

Konfektionierung durch / Packed by:

Datum der Konfektionierung / Date of packaging:



**SW-MOTECH GmbH & Co. KG**  
Ernteweg 7-10  
35282 Rauschenberg  
Germany

Tel. / phone + 49 (0)6425 / 8168 - 050  
Fax / fax + 49 (0)6425 / 8168 - 10  
**info@sw-motech.com**  
**www.sw-motech.com**

## STÜCKLISTE / PARTS LIST

Schritt Step	Nr. No.	Art.-Nr. / Bezeichnung <sup>a</sup> Item No. / Description <sup>a</sup>	Artikel	Part	Anzahl <sup>b</sup> Quantity <sup>b</sup>	N·m <sup>c</sup>
		<b>BC.HTA.00.740.3000*</b>	<b>PRO BLAZE® Satteltaschen</b>	<b>PRO BLAZE® Saddlebags</b>		
<b>1</b>	(1)	BC.ZUB.00.019.30000	Klickverschluss	Buckle	2 / 2	
	(2)	LSF.350.250	Lackschutzfolie; 250 x 350 mm	Protection Foil; 250 x 350 mm	2 / 2	
<b>2</b>	(3)	BC.HTA.00.740.901.01 / 902.01	Satteltasche; links / rechts	Saddlebag; left / right	2 / 2	
<b>3</b>	(4)	BC.ZUB.00.064.30000	Wasserdichte Innentasche	Waterproof Innerbag	2 / 2	
		<b>BC.HTA.00.740.3100*</b>	<b>PRO BLAZE® Satteltaschen hohe Version</b>	<b>PRO BLAZE® Saddlebags high version</b>		
<b>1</b>	(1)	BC.ZUB.00.019.30000	Klickverschluss	Buckle	2 / 2	
	(2)	LSF.350.250	Lackschutzfolie; 250 x 350 mm	Protection Foil; 250 x 350 mm	2 / 2	
<b>2</b>	(3)	BC.HTA.00.740.901.02 / 902.02	Satteltasche; links / rechts	Saddlebag; left / right	2 / 2	
<b>3</b>	(4)	BC.ZUB.00.064.30000	Wasserdichte Innentasche	Waterproof Innerbag	2 / 2	

	Regelgewinde / Coarse Thread Ø	M4	M5	M6	M8	M10	M12		Regelgewinde / Coarse Thread Ø	M4	M5	M6	M8	M10	M12		
<b>8.8</b>	Stahl FK 8.8 / Steel CL 8.8	<b>N·m</b>	2,8	5,5	9,6	23	46	79	<b>10.9</b>	Stahl FK 10.9 / Steel CL 10.9	<b>N·m</b>	4,1	8,1	14	34	67	115

**Anmerkungen:** <sup>a</sup> Alle Maßangaben in Millimeter. <sup>b</sup> Der zweite Wert gibt die Gesamtanzahl des jew. Artikels in der Lieferung an. <sup>c</sup> **Keine Anzugsmomentvorgabe: Verwenden Sie das vom Fzg.-Hersteller definierte Anzugsmoment!** Das Std.-Anzugsmoment der Tabelle kann verwendet werden, wenn es den Fzg.-Hersteller-Vorgaben entspricht.

**Note:** <sup>a</sup> All measurements in millimeters. <sup>b</sup> The second number indicates the total quantity of the part in the delivery. <sup>c</sup> **No torque specifications: Use the torque defined by vehicle manufacturer!** The standard torque in this table can be used as long as it is within the vehicle manufacturer's specifications.



1

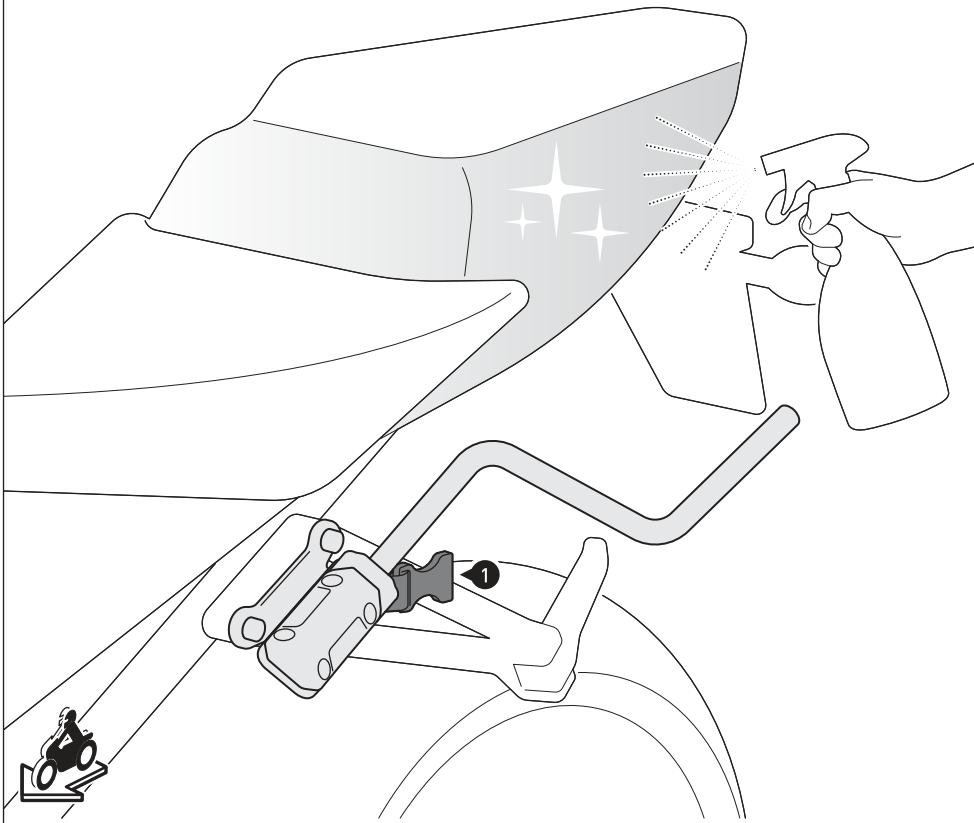

**DE** - Nachdem Sie die Abstandsbügel an Ihrem Fahrzeug montiert haben, müssen Sie die Auflageflächen der Satteltaschen mit der beige packten Lackschutzfolie (2) bekleben, um Beschädigungen zu vermeiden. Reinigen Sie die zu beklebende Fläche vor dem Aufbringen der Lackschutzfolie gründlich von Fett- und Schmutzrückständen.

**ACHTUNG: Scharfkantige Ecken müssen mit mehreren Schichten der Lackschutzfolie beklebt werden!**

Prüfen Sie nach Anbringung der Satteltaschen, ob die betroffenen Fahrzeugbereiche ausreichend gegen Abrieb geschützt sind.

**EN** - After mounting the saddlebags frames you need to protect the surface of the motorcycle against scratches with the included protection foil (2).

Clean the surface from grease and dirt before applying the protection film.

**ATTENTION: Sharp edges have to be covered with several layers of the protection foil!**

After mounting the saddle bags, check if the affected parts of the vehicle are sufficiently protected against abrasion.

**FR** - Après avoir fixé les sacoches, vous devez protéger le revêtement de la moto contre les rayures en utilisant le film de protection fourni (2). Nettoyer la surface de toute trace de gras ou de salissure avant d'appliquer le film de protection.

**ATTENTION : Les angles pointus doivent être recouverts de plusieurs couches de film de protection !**

Après le montage des sacoches, vérifiez que les pièces concernées de la moto sont suffisamment protégées contre l'abrasion.

**ES** - Tras montar la estructura de las alforjas, se debe proteger la superficie de la motocicleta de posibles ralladuras con las lámina protectora que se incluye (2). Limpie la grasa y suciedad de la superficie antes de aplicar la película protectora.

**ATENCIÓN: Los bordes afilados se deben cubrir con varias capas de lámina protectora.**

Tras montar las bolsas, compruebe que las partes del vehículo afectadas están suficientemente protegidas contra abrasiones.

**IT** - Dopo il montaggio dei telai delle borse è necessario proteggere la superficie della moto contro graffi con la pellicola di protezione fornita in dotazione (2). Pulire la superficie da grasso e sporco prima di applicare la pellicola di protezione.

**ATTENZIONE: in caso di presenza di spigoli vivi, questi devono essere coperti con più strati di pellicola protettiva!**

Dopo aver montato le borse, verificare che le parti del veicolo interessate siano sufficientemente protette contro l'abrasione.

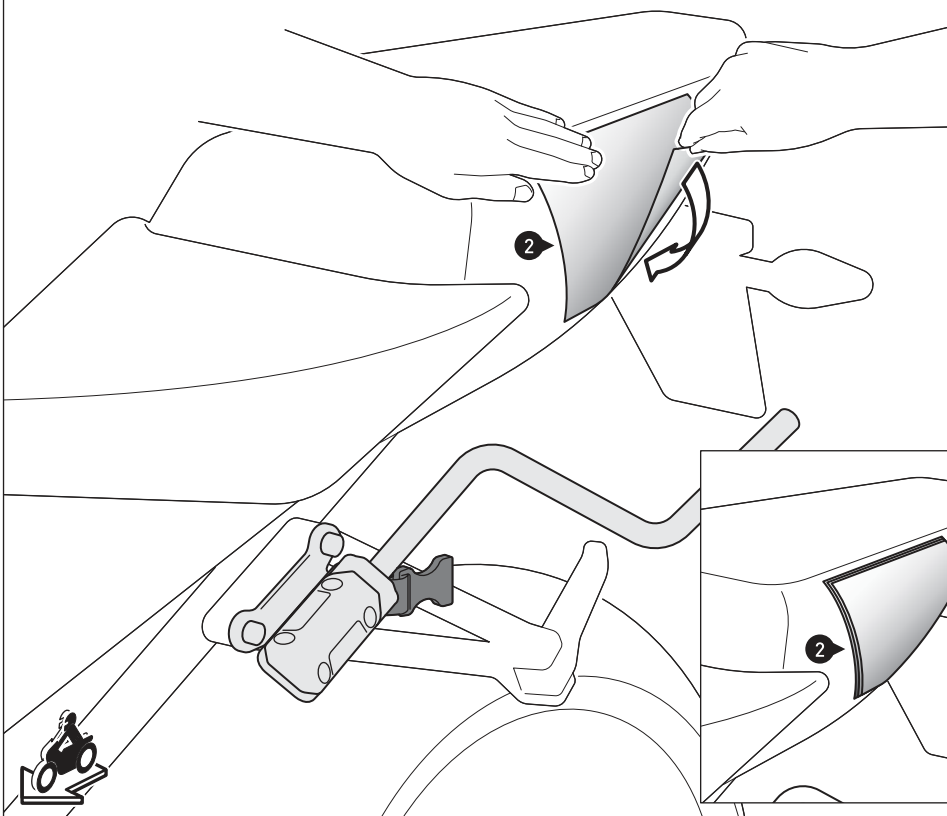

2

Haltetasche / sleeve

Abstandsbügel / support arm

3

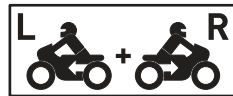

Schieben Sie die Haltetaschen der Satteltaschen (3) **beidseitig** über die zuvor montierten Abstandsbügel.

Slide the pannier sleeves of the saddlebags (3) on **both sides** onto the mounted support arms.

3



Klettaschen / Velcro Flaps

3

Verketten Sie die Klettaschen der Satteltaschen (3) über das Heck (Sozius-Sitz) des Fahrzeugs, wie in der Zeichnung gezeigt.

**ACHTUNG:** Achten Sie unbedingt darauf, dass nach dem Beladen der Satteltaschen (3) **KEINE** Last auf den Abstandsbügel(n) liegt! Die Lastaufnahme darf ausschließlich über die Klettaschen der Satteltaschen (3) erfolgen, **NIEMALS** über die Abstandsbügel! Die Abstandsbügel müssen nach Beladung wie in der Detailzeichnung gezeigt in den Haltetaschen positioniert sein!

Fasten the saddlebags (3) with the velcro flaps over the rear (passenger seat) of the motorcycle, as shown in the drawing.

**ATTENTION:** Make sure after loading the saddlebags (3) there is **NO** weight on the saddlebags frames!

The weight of the saddlebags (3) must be supported by the velcro flaps, **NEVER** by the saddlebags frames.

After loading, the saddlebags frames must be positioned in the saddlebags sleeves, as shown in the detail drawing!

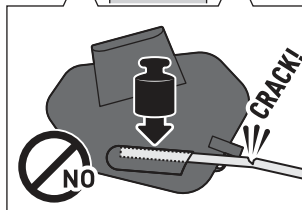
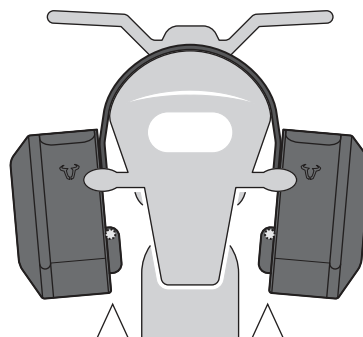
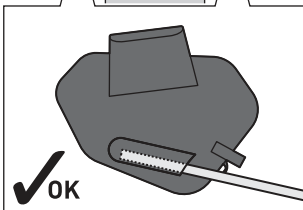
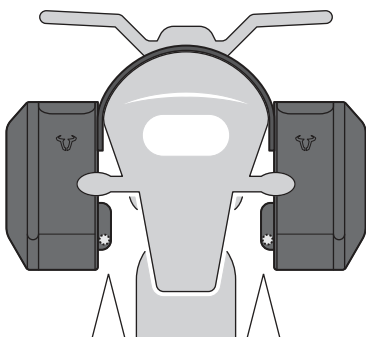

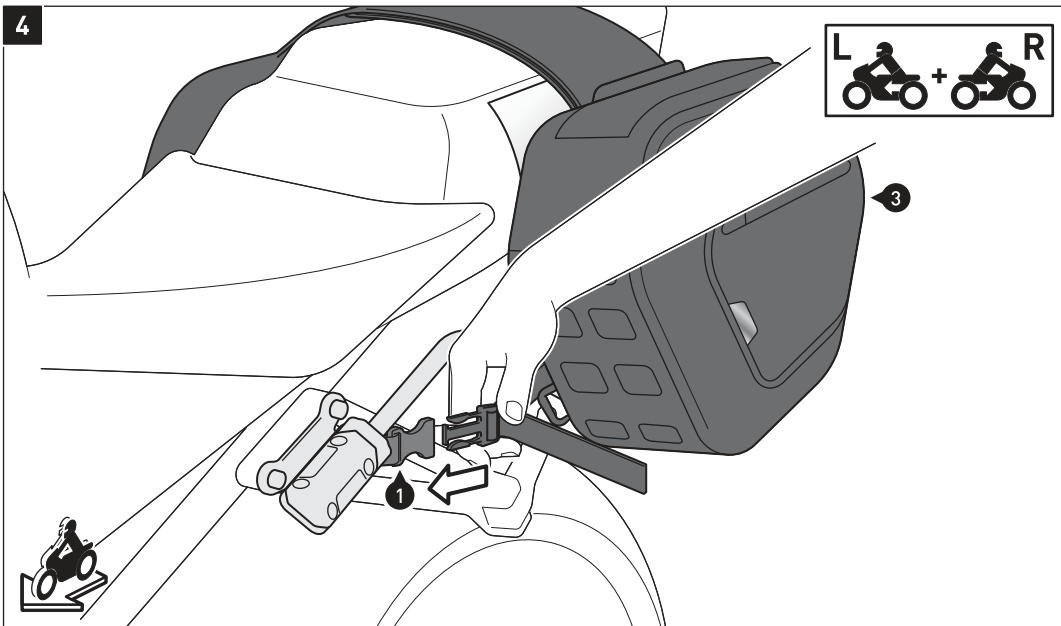

**ACHTUNG:** Beachten Sie unbedingt die den Satteltaschen Abstandsbügeln beiliegende Anbauanleitung!

Rasten Sie nun die Sicherungsgurte der Satteltaschen (3) in die zuvor lose verschraubten Klickverschlüsse (1) ein. Ziehen Sie jetzt die Schrauben der Klickverschlüsse (1) an, wie in der Anbauanleitung der Satteltaschen Abstandsbügel beschrieben.

**ATTENTION:** Pay attention to the mounting instructions included to the saddlebags support arms!

Fix the saddlebags (3) with the safety straps (1) on **both sides**. Then tighten the screws of the buckles (1) as described in the mounting instructions of the saddlebags support arms.



Ziehen Sie die Sicherungsgurte an, um die Satteltaschen (3) zu sichern.

**ACHTUNG:** Achten Sie VOR jeder Fahrt darauf, dass die Klettaschen und Sicherungsgurte fest verspannt sind und die Abstandsbügel KEINE Last tragen! Durch nicht korrekt verspannte Satteltaschen (3) können Schäden am Produkt und Fahrzeug entstehen!

Rollen Sie abschließend die Überlängen der Sicherungsgurte auf und sichern Sie diese.

Tighten the safety straps to secure the saddlebags (3).

**ATTENTION:** Make sure BEFORE each ride that the velcro flaps and safety straps of the saddlebags (3) are firmly tightened and there is NO weight on the support arms! Wrong mounted saddlebags (3) can damage the product and vehicle!

Finally roll up the excess safety strap length and secure it.

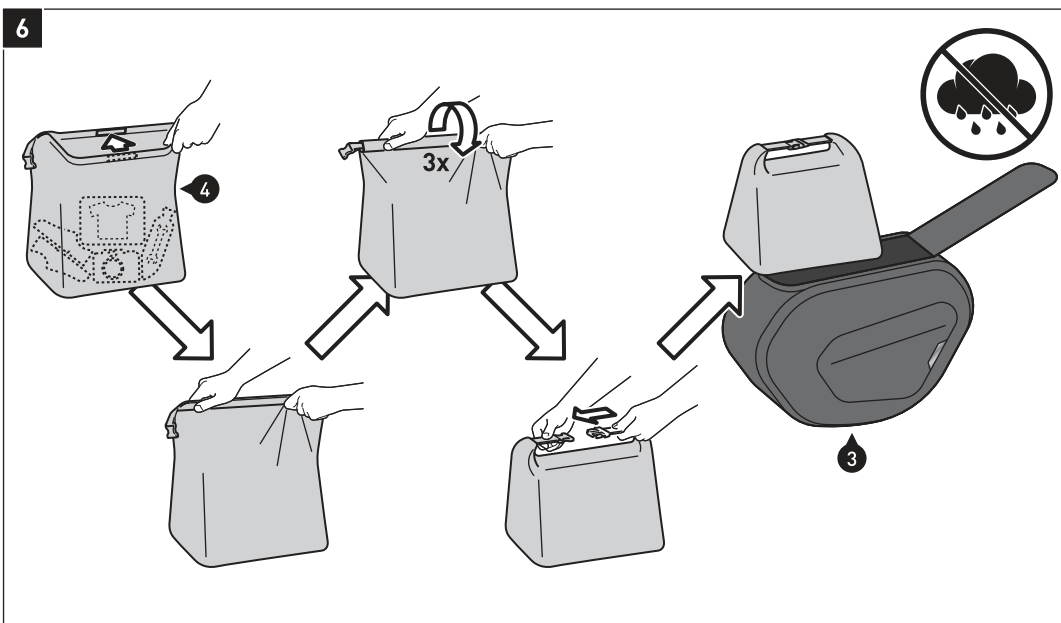

Verwenden Sie die wasserdichten Innentaschen (4), um Ihr Gepäck vor Feuchtigkeit zu schützen. Schützen Sie empfindliches Gepäck (z. B. elektronische Geräte) zusätzlich mit einer Plastiktüte vor Feuchtigkeit.

Use the waterproof inner bags (4) to protect your luggage from moisture. Additionally protect sensitive luggage (e.g., electronic equipment) from moisture with a plastic bag.

**SICHERHEIT UND BELADUNG:**  
Achten Sie auf die gleichmäßige Verteilung der Ladung zwischen den Satteltaschen! Stellen Sie sicher, dass die Ladung während der Fahrt gegen Verrutschen gesichert ist!  
Keine scharfkantigen / zerbrechlichen Gegenstände verstauen!  
Auf dem MOLLE-Aufsatz NUR zugewiesene SW-MOTECH-Produkte verschlaufen!

**ACHTUNG: Entfernen Sie die Abstandsbügel bei Fahrten OHNE Satteltaschen vom Fahrzeug!**

Stellen Sie sicher, dass keine Komponente des Produkts mit heißen und beweglichen Teilen des Fahrzeugs in Berührung kommen kann. Achten Sie darauf, dass alle Komponenten mindestens 5 cm Abstand zu heißen Teilen sowie dem heißen Abgasstrom des Auspuffs haben.

**ACHTUNG: Die Kompatibilität mit Zubehör-Auspuffanlagen kann nicht gewährleistet werden!**

**SAFETY AND LOADING:** Make sure weight is evenly distributed between the sagglesbags. Make sure that the loading is secured against shifting during the ride!

Do not store sharp or fragile objects!

ONLY loop assigned SW-MOTECH products to the MOLLE attachment!

**ATTENTION: Remove the support arms when driving WITHOUT saddlebags from the vehicle!**

All components of the product must not contact any hot or moving parts of the vehicle. All parts should also remain 5 cm away from hot parts of the vehicle and remain clear of the exhaust stream.

**ATTENTION: Compatibility with accessory exhaust systems cannot be guaranteed!**

**PFLEGE:** Verwenden Sie zur Reinigung NUR eine weiche Textilbürste, ein Tuch oder Schwamm und warme Seifenlauge! Spülen Sie anschließend mit klarem Wasser nach.

Verwenden Sie KEINE scharfen Reinigungsmittel, raue Putzutensilien oder einen Hochdruckreiniger! Reinigen Sie das Produkt unbedingt nach Winterfahrten, um Schäden durch das Salz zu vermeiden.

**CARE:** For cleaning use ONLY a soft textile brush, cloth or sponge and warm soapy water! Rinse with clean water.

Do NOT use strong cleaning agents, rough cleaning tools or high pressure washer! Clean the product after riding in salty conditions, to avoid damage from salt.

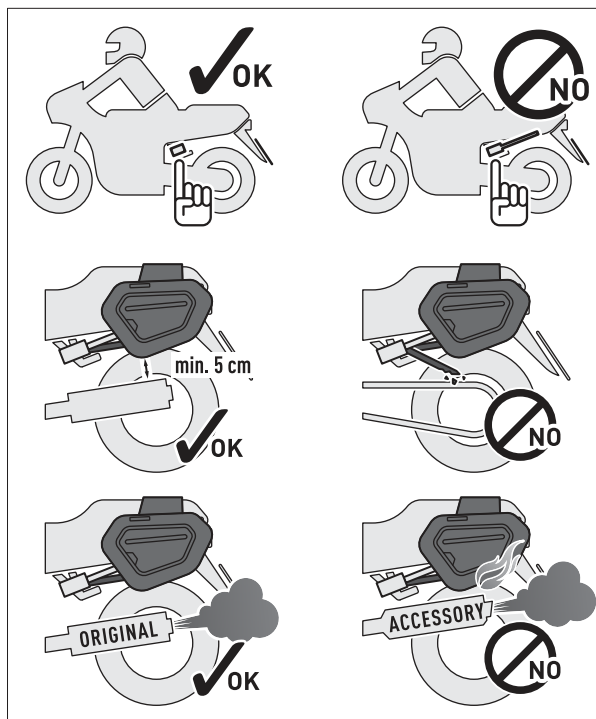
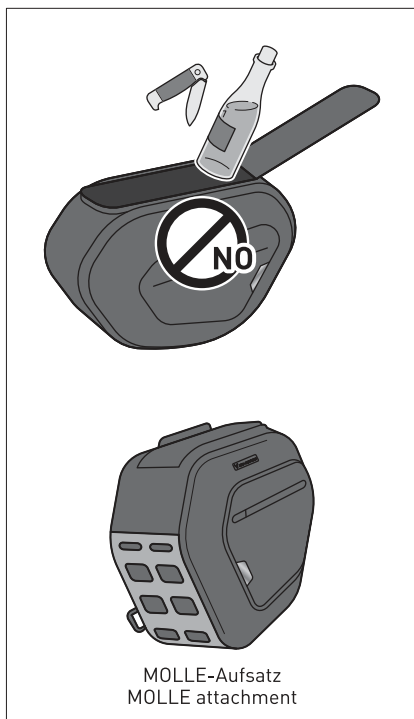
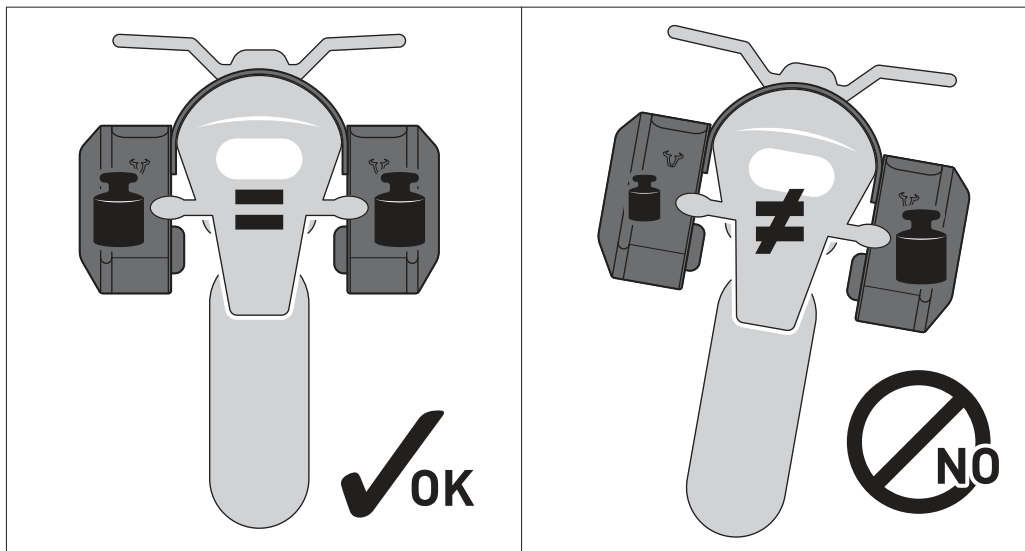

**ACHTUNG:** Oberflächenmaterialien können bei längerer und intensiver Sonneneinstrahlung und Umwelteinflüssen (z. B. SMOG, saurer Regen, etc.) Farbveränderungen (Ausbleichen) unterliegen! Benzin und ähnliche Stoffe müssen sofort abgewaschen werden! SW-MOTECH übernimmt für Farbveränderungen keine Haftung!

**ATTENTION:** Surface materials can experience color changes or fading when exposed to direct sunlight for extended periods of time and by environmental factors (e.g., SMOG, acid rain, etc.)! Gasoline and similar substances must be washed off immediately! SW-MOTECH assumes no liability for color changes!

